









# ECtemp 130 (EFET 130), ECtemp 132 (EFET 132)

**ECtemp 130/132** is a line of simple electronic 16 Amps thermostats with possibility to be installed directly on the wall. The thermostats have only one button for adjusting the temperature and for OFF mode. Furthermore, it has an LED indicator showing standby (green light) and heating (red light) periods. The thermostats do not have wire sensor failure monitoring. Wire temperature sensor included in the set.

**ECtemp 130** is equipped with a wire (floor) sensor used for control of Comfort Floor Heating applications. The thermostat has a dial for adjusting the temperature setting with a numeric scale from   to 5 (meaning from OFF, 5 °C to 45 °C and each step corresponds to approx. 9 °C). This type of thermostat can be used for outdoor applications too – Ice and Snow Melting on Ground, Frost Protection on Roofs, Pipe Tracing, etc., because it doesn't have wire sensor failure monitoring.

**ECtemp 132** is equipped with a built-in air sensor to control the room temperature and an additional floor (wire) sensor to limit the maximum floor temperature. The main application is Total (Direct) Heating via Floor systems. The thermostat has a dial for adjusting the room temperature, with a degree scale from   to 35 °C (which means from OFF, 5 °C to 35 °C). Adjusting maximum floor temperature is provided with potentiometer placed under front cover (default 35 °C).

## Technical specifications

<b>Benefits</b> <ul style="list-style-type: none"> <li>• Low standby consumption</li> <li>• Installation on the wall</li> <li>• LED indication</li> <li>• Frost protection</li> <li>• Ice and snow melting applications</li> </ul> <b>Approvals:</b>  <b>Standard compliance</b> <ul style="list-style-type: none"> <li>• EN/IEC 60730-1 (general)</li> <li>• EN/IEC 60730-2-9 (thermostat)</li> </ul>	Operation voltage	220 - 240 V, 50/60 Hz
	Standby power consumption	Max. 5 W
	Resistive load	Max. 16 A (3680 W) @ 230 V
	Inductive load	Max. 1 A, $\cos \varphi = 0,3$
	Hysteresis	$\pm 0,2^{\circ}\text{C}$
	Ambient temperature	-10 °C to +30 °C
	Frost protection	5 °C - 
	Cable specification max	1 x 4 mm <sup>2</sup> or 2 x 2,5 mm <sup>2</sup>
	Ball pressure test temperature	75 °C
	Pollution degree	2 (domestic use)
	Controller type	1 C
	Storage temperature	-20 °C to +65 °C
	IP class	IP 30
	Protection class	Class II - 
	Dimensions (H/W/D)	82 x 82 x 36 mm
	Weight	90 g

## Types

Item no.	Product name	Temp. range	Sensor type	Marking	EAN no.
088L0030	<b>ECtemp 130</b>	5-45 °C	Wire sensor, 3 m, NTC 15 kOhm at 25 °C	D130	5703466126714
088L0032	<b>ECtemp 132</b>	Room: 5-35 °C, max. floor temp.: 20-50 °C (default 35 °C)	Built-in room sensor and wire sensor, 3 m, NTC 15 kOhm at 25 °C	D132	5703466126738

Connection schemes

**ECtemp 130**

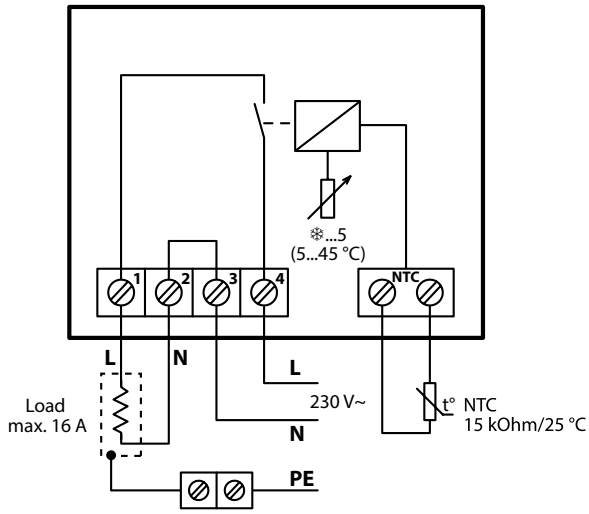

**ECtemp 132**

