

bticino

MATIX

Inovativne boje.
Nove funkcije.



KATALOG 2010

MATIX

Inovativne boje.
Nove funkcije.



MY HOME

SADRŽAJ

OSNOVNE ZNAČAJKE

MÄTIX novi oblik kvalitete	2
Široka paleta novih boja za MÄTIX	4
S MÄTIX-om, kućna automatika postaje standard	8
Potpuna paleta proizvoda za sve prostore	10
Novi nosivi okviri	12
MÄTIX i IDROBOX: idealno rješenje za zaštitu	13

KATALOG PROIZVODA

MÄTIX - katalog proizvoda	15
---------------------------	----

UKRASNI OKVIRI: IZBOR BOJA I OBLIKA

31

IDROBOX I IDROBOX PLUS

39

MÀTIX

Novi oblik kvalitete

Novi oblik ukrasnih okvira
mijenja doživljaj Vašeg
prostora.





Svi ukrasni okviri
imaju debljinu samo
6 mm.



MÀTIX potpuno
novi dizajn:

- ▶ **atraktivne boje**
- ▶ **neprimjetna debljina**
- ▶ **pogodan za svako okruženje**

Široka paleta novih boja za MÀTIX

24 nove boje podijeljene su u 5 grupa: Neutralne, Metalik, Boje, Teksture i Galvanizirane, koje se savršeno uklapaju u današnje trendove u dizajnu interijera.

NEUTRALNE



METALNE



GALVANIZIRANE

TEKSTURE



BOJE



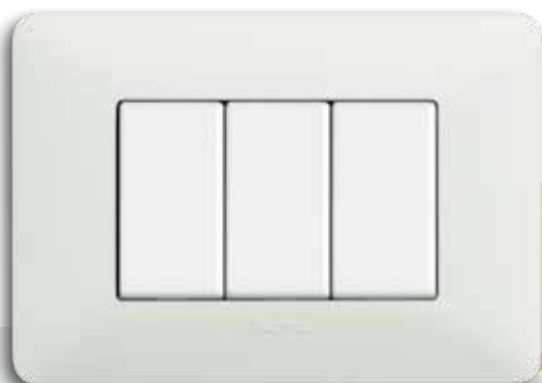

▲ SKLOPKE sa Bijelim ukrasnim okvirom.

NEUTRALNE

Osnovne boje: Bijela, Bjelokost, Pepeo i Pijesak.

Nadopunjuju najpopularnije boje zidova.



METALNE

Metalni efekt.

Zlato, Željezo, Srebro, Titan.

Ukrasni okviri sa metalnim efektom pogodni su za sve prostore.

▼ Sklopka sa Titan ukrasnim okvirom.

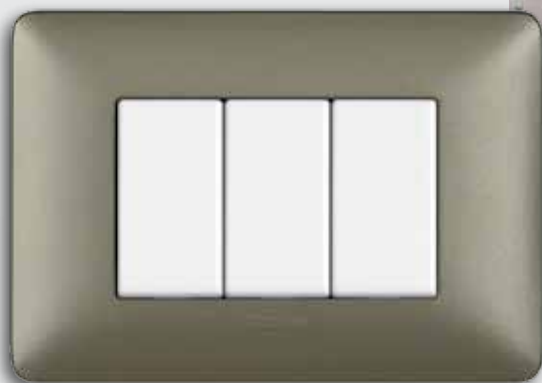

Široka paleta novih boja za MÀTIX

BOJE

Polirana površina sa sjajnim efektom.

Osam različitih boja podijelili smo u dvije grupe sa sličnim karakteristikama.

Svijetle boje:

Crvena, Narančasta, Plava, Tamno zelena

Snažne i svijetle boje, za prostore sa karakterom.

▼ Sklopke sa ukrasnim okvirom Crvene boje.

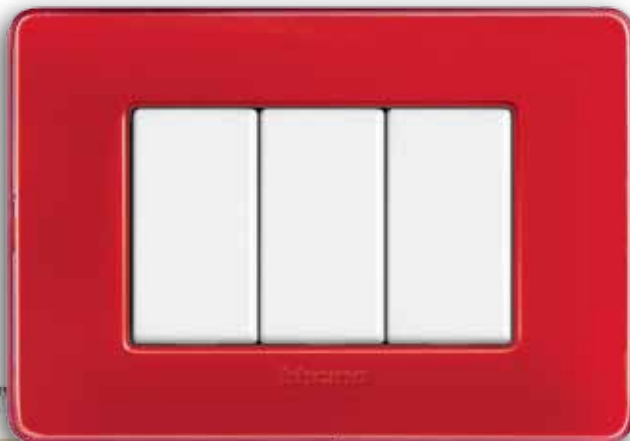

▲ Sklopke sa ukrasnim okvirom Zelene boje.

Nježne boje:

Ledeno bijela, Krem, Zelena i Tirkizno plava.

Paleta nježnih boja za diskretan dizajn.



TEKSTURE

Poseban izgled tekstura:
Limun bijela, Terracotta, Tamno smeđa,
Mercury plava.
Originalni izgled i elegancija.

▶ Sklopke sa
ukrasnim okvirom
Terracotta boje.



GALVANIZIRANI

Boje dragocenih metala: Sjajni Krom, Tamni Nikal,
Sjajno Zlatna i Saten Zlatna.

Izaberite između sjajnih i saten ukrasnih okvira, u skladu sa metalnim detaljima u vašem prostoru.

▲ Sklopke sa Saten zlatnom bojom ukrasnog okvira.

S MÀTIX-om kućna automatika postaje standard

TERMOREGULACIJA ▶

Kronotermostat s ukrasnim okvirom Srebro ▶

AUTOMATIKA ▶

Infracrveni prijemnik i ON-OFF sklopka u Tamno plavom ukrasnom okviru ▶

MY HOME je BTicino sustav kućne automatike koji nudi moderne funkcije i rješenja prilagođene svakom pojedinom korisniku i prostoru. Uređaji MY HOME također su dostupni i u MÀTIX liniji proizvoda povećavajući udobnost, sigurnost i uštede te pružajući komunikaciju i kontrolu nad vašim prostorom.





◀ DIGITALNE KONTROLE

◀ Ekran na dodir s ukrasnim okvirom Saten zlatna



◀ PROTUPROVALNI SUSTAV

◀ Sklopka za aktivaciju alarma s Tamnozelenim ukrasnim okvirom



◀ SUSTAV OZVUČENJA

◀ Sklopke za upravljanje sustavom ozvučenja u Tamno smeđem ukrasnom okviru

MY HOME

Potpuna paleta proizvoda za sve prostore

MÀTIX:
MY HOME ekran na dodir

SWING video ▶
portafon

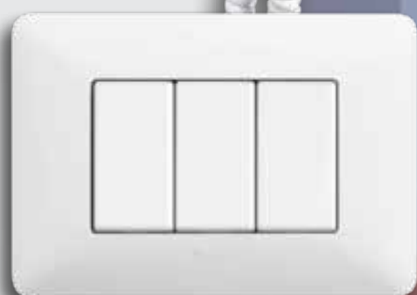

▲ MÀTIX: standardni
uređaji

▶
MÀTIX:
MY HOME
digitalne
kontrolne



IDROBOX: ▶
IP55 zaštita



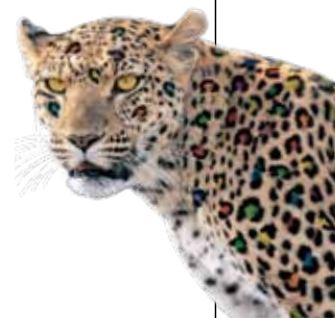

◀ POLYX VIDEO EKLAN:
video portafon bez slušalice



▲ Modular SFERA
ulazni panel



◀ IDROBOX PLUS:
IP55 tipkalo
sa nosačem imena

Novi nosivi okviri

Svi MÀTIX nosivi okviri su modificirani kako bi se olakšala instalacija novih ukrasnih okvira.
Svi kataloški brojevi ostali su nepromijenjeni (*).

Glavne karakteristike su:

- **Novi oblik (zaobljeni rubovi)**
- **"MÀTIX" oznaka umjesto "TT nosač"**

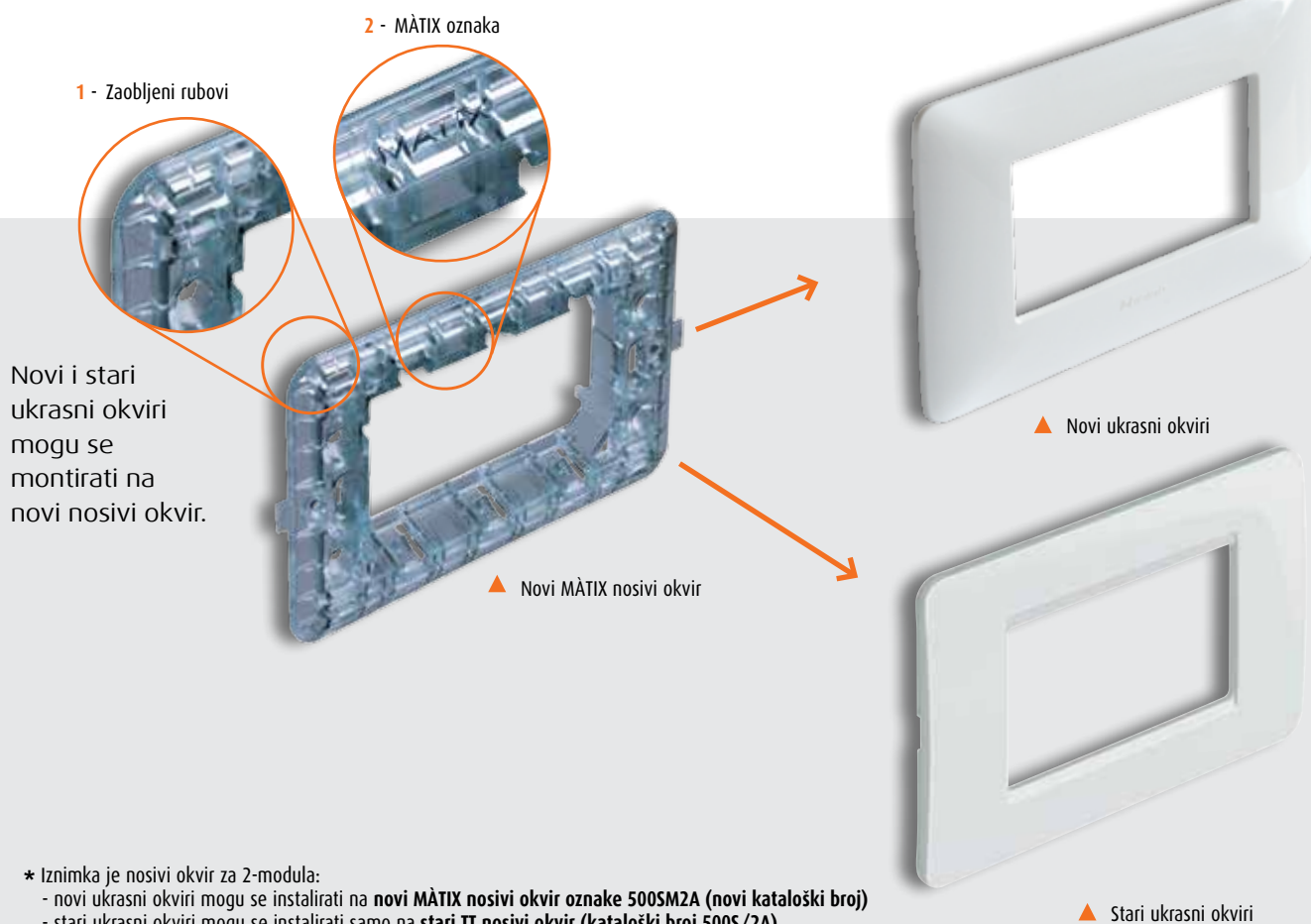

* Iznimka je nosivi okvir za 2-modula:
- novi ukrasni okviri mogu se instalirati na **novi MÀTIX nosivi okvir oznake 500SM2A (novi kataloški broj)**
- stari ukrasni okviri mogu se instalirati samo na **stari TT nosivi okvir (kataloški broj 500S/2A)**

■ STARI NOSIVI OKVIR

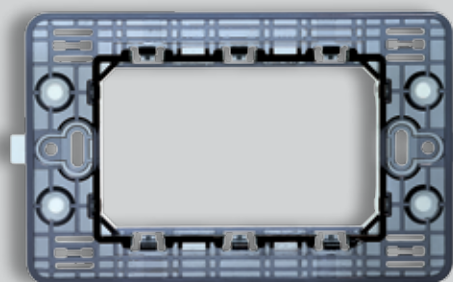

Stari nosivi okvir - TT - kataloški broj 503SA

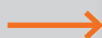

Novi ukrasni okviri



Novi ukrasni okviri ne mogu se montirati na stari TT nosivi okvir.

MÀTIX i IDROBOX: idealno rješenje za zaštitu



INSTALACIJA U ZAŠTIĆENE KUTIJE: IDROBOX SISTEM

MÀTIX uređaji se mogu ugraditi u IDROBOX kućište, bez posebnih adaptera.

Potpuna linija IP40 i IP55 kućišta pogodna je za sve namjene: za podrum, radionice, trgovine i razna radna okruženja.



◀ IP55 okvir za 503E kutiju



▲ IP55 i IP40 nadzbučne kutije

IDROBOX I IDROBOX PLUS OPREMA:

IP55 uređaji i kućišta bez poklopca i IP66 kućište sa utičnicom.



▲ Kućište s poklopcem



▲ Izmjenična sklopka i tipkalo



◀ Tipkalo sa oznakom imena

▶ Izmjenična sklopka i kućište s poklopcem



▲ IP66 kućište

■ ELIMINIRA SVE PROBLEME SA VLAGOM ILI PRAŠINOM

■ MAKSIMALNA I DUGOTRAJNA OTPORNOST NA VREMENSKE UVJETE

■ UNAPRIJEĐEN DIZAJN: DIREKTNJA KONTROLA UREĐAJA I UPRAVLJANJE

MÀTIX

KATALOG PROIZVODA

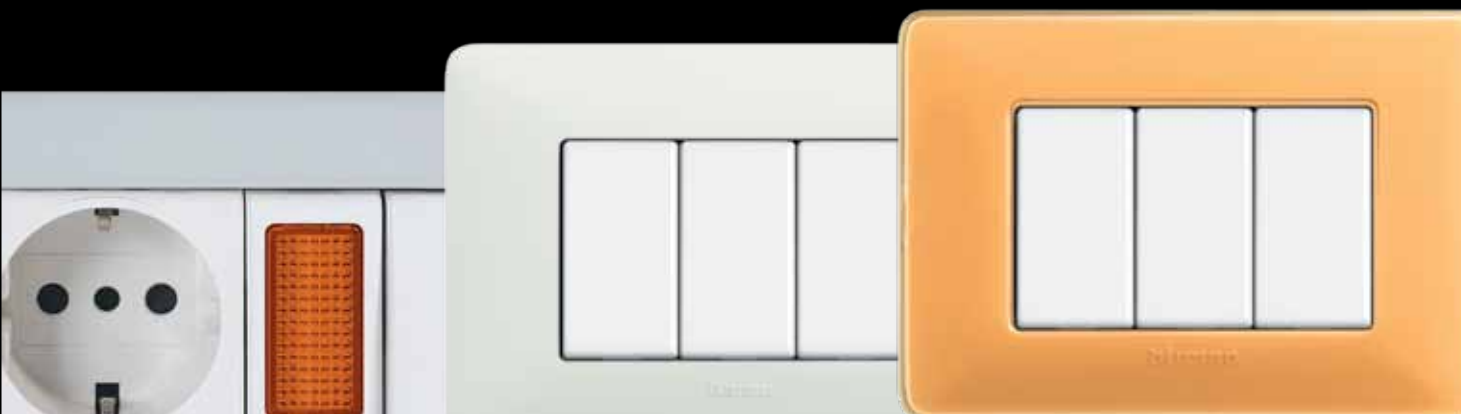

SADRŽAJ

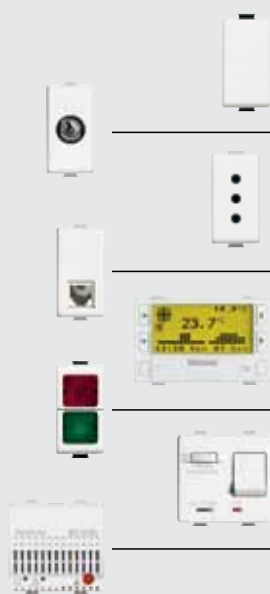

Katalog proizvoda

16	Osnovni uređaji i pokrovne tipke
19	TV i specijalne utičnice
20	Utičnice
22	RJ i EDP utičnice
23	Elektronički uređaji za regulaciju
25	Zvučna i svjetlosna signalizacija
27	Sigurnosni uređaji
28	Detektori plina
29	Lampice - kutije za ugradnju i dodatni pribor

Osnovni uređaji

BIJELI MEHANIZMI



AM5001 AM5011 AM5011/32
AM5003



AM5001/2
AM5003/2

AM5007 - AM5007C
AM5007D - AM5007DC



AM5012 AM5012/2



AM5052 AM5052/2



AM5124 AM5086



AM5332/230 AM5315
AM5332/24 AM5315/34
AM5332/12



AM5305

KREM MEHANIZMI



A5001 A5011 A5011/32
A5003



A5007
A5007D



A5012



A5052N



A5124 A5086



A5332/230 A5315
A5315/34

SKLOPKE

Kat. br.	Opis
AM5001	1P 16A - 250Va.c.
A5001	
AM5001/2	1P 16A - 250Va.c. - 2 modula
AM5011	2P 16A - 250Va.c.
A5011	
AM5011/32	2P 32A - 250Va.c.
A5011/32	
AM5007	2P 16A - 250Va.c. sa ključem- ključ se može izvaditi i u
AM5007	OFF poziciji - ključevi su različiti
AM5007C*	2P 16A - 250Va.c. sa ključem - kao gore - isti ključ
* Za naručivanje ovih proizvoda kontaktirajte nas	

IZMJENIČNE SKLOPKE

Kat. br.	Opis
AM5003	1P 16A - 250Va.c.
A5003	
AM5003/2	1P 16A - 250Va.c. - 2 modula
AM5007D	1P 16A - 250Va.c. sa ključem- ključ se može izvaditi i u
A5007D	OFF poziciji - ključevi su različiti
AM5007DC*	1P 16A - 250V a.c. sa ključem - kao gore - isti ključ
* Za naručivanje ovih proizvoda kontaktirajte nas	

KRIŽNE - PREKLOPNE SKLOPKE - SKLOPKA S KLJUČEM- GREBENASTE SKLOPKE

Kat. br.	Opis
AM5012	križna sklopka 16A - 250Va.c.
A5012	
AM5012/2	križna sklopka 16A - 250Va.c. - 2 modula
AM5052	preklopna sklopka 1P 16A - 250Va.c.
A5052N	
AM5052/2	preklopna sklopka 1P 16A - 250Va.c. - 2 modula
AM5124	sklopka s ključem i 2NO kontakta- 10A 48V
A5124	(za Kat. br. 2124N)
AM5086	grebenasta sklopka - 1P 3A - 250Va.c. - 1 smjer
A5086	- 4 pozicije za kontrolu klime, sušila za kosu, itd.

MONOSTABLNI RELEJI

Kat. br.	Opis
AM5332/230	monostabilni relej sa NO/NC kontakt 250V a.c. 10A otporan 4A
A5332/230	induktivan napajanje 230V a.c.
AM5332/24	relej kao gore - napajanje 24V a.c.
AM5332/12	relej kao gore - napajanje 12V a.c.

ELEKTRONIČKI CIKLIČKI RELEJI

Kat. br.	Opis
AM5315	ciklički relej 10AX 230V a.c. 3 žice
A5315	
AM5315/34	ciklički relej 10AX 230V a.c. 3-4 žice
A5315/34	

AUDIO POTENCIOMETAR

Kat. br.	Opis
AM5305	audio potencijometar 0-5W 47 Ohm

BIJELI MEHANIZMI

 AM5005 AM5055 AM5037
 AM5005/1

 AM5005/2 AM5055/2
 AM5037/2

AM5005/2A AM5005/2D



AM5006



AM5054 AM5008



AM5057R AM5057V AM5057A



AM5007P

 AM5001L
 AM5003L
 AM5005L

KREM MEHANIZMI

 A5005N A5055 A5037
 A5005/1N

A5006



A5054 A5008



A5057R A5057V A5057A

TIPKALA

Kat. br.	Opis
AM5005	1P (NO) 10A - 250Va.c.
A5005N	
AM5005/1	1P (NC) 10A - 250Va.c.
A5005/1N	
AM5005/2	1P (NO) 10A - 250Va.c. - 2 modula
AM5055	dvostruko 1P (NO) + 1P (NO) 10A - 250Va.c.
A5055	
AM5055/2	dvostruko 1P (NO) + 1P (NO) 10A - 250Va.c. - 2 modula
AM5037	dvostruko 1P (NO) + 1P (NO) 10A - 250Va.c. povezano
A5037	
AM5037/2	dvostruko 1P (NO) + 1P (NO) 10A - 250Va.c. povezano - 2 modula
AM5005/2A	tipkalo 1P (NO) 10A - 250Va.c. oznaka svjetla - 2 modula
AM5005/2D	tipkalo 1P (NO) 10A - 250Va.c. oznaka zvona - 2 modula
AM5006	1P (NO) 10A - 250Va.c. potezno tipkalo
A5006	
AM5054	2P (NO) 10A - 250Va.c.
A5054	
AM5008	tipkalo 1P (NO) + nosač oznake za lampice 11250L,
A5008	11250LV, 11251L, 11252L
AM5057R	1P (NO) 10A - 250Va.c. + nosač za lampice 11250L, 11251L ili
A5057R	11252L - crveni difuzor
AM5057V	1P (NO) 10A - 250Va.c. + nosač za lampice 11250LV, 11251L ili
A5057V	11252L - zeleni difuzor
AM5057A	1P (NO) 10A - 250Va.c. + nosač za lampice 11250L, 11251L ili
A5057A*	11252L - narančasti difuzor
AM5007P*	tipkalo 2P (NO) 10A - 250Va.c. sa ključem - mogu se izvući jedino u OFF poziciji - ključevi su razlikuju jedan od drugog.

* Svaki uređaj ima svoju posebnu bravicu. Ukoliko imate potrebu za nekoliko uređaja sa istim ključem i bravicom, kontaktirajte nas.

OSVJETLJENA UREĐAJI

Kat. br.	Opis
AM5001L	sklopka 1P 16A - 250V a.c. - osvijetljena
AM5003L	izmjenična sklopka 1P 16A - 250V a.c. - osvijetljena
AM5005L	tipkalo 1P NO 10A - 250V a.c. - osvijetljena

Slijepi moduli

BIJELI MEHANIZMI



AM5000



AM5009



AM5000P/2



AM5009/2



AM5921...



AM5921W



AM5921/2...



KREM MEHANIZMI



A5000



A5009



A5921...



A5921W

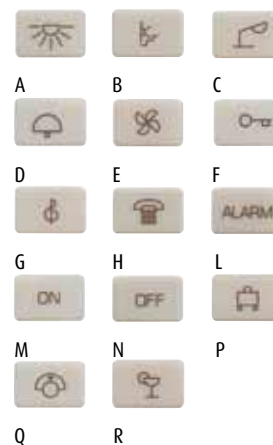

SLIJEPE POKRIVNE PLOČICE I IZLAZI KABELA

Kat. br.	Opis
AM5000	slijepa pločica
A5000	
AM5000P/2	slijepa pločica sa pripremljenom izlaznom rupom - 2 modula
AM5009	slijepa pločica sa izlaznom rupom \varnothing 9.5 mm - 1 modul
A5009	
AM5009/2	slijepa pločica sa izlaznom rupom \varnothing 9.5 mm - 2 modula

SLIJEPE POKRIVNE PLOČICE SA OSVJETLJENIM OZNAKAMA

Kat. br.	Opis
AM5921...	pokrivna pločica sa izmjenjivim oznakama simbola
A5921...	slovo simbola označava kompletan kataloški broj
AM5921/2...	kao gore - 2 modula
AM5921W	pločica sa bijelim nosačem
A5921W	

NAPOMENA: upotrijebiti kao zamjenu za A/AM5001, A/AM5003, A/AM5005, A/AM5012

TV i specijalne utičnice

BIJELI MEHANIZMI



AM5173D AM5173P AM5173DC
AM5173PT



AM5173SAT



AM5175D AM5173DF



AM5164/2 AM5163/3



AM5020 AM5120 AM5189



AM5190

KREM MEHANIZMI



A5173D A5173P A5173DC
A5173PT



A5173SAT



A5020N A5120

TV UTIČNICE

Kat. br.	Opis
AM5173D A5173D	oklopljene utičnice za sistem sa pojedinačnim korisnikom i za daljinski upravljive i centralizirane satelitske sisteme te centraliziranim prolazom prema odabranim kanalima - zaštićeni izliveni spoj sa vijcima - Ø 9.5 mm - muški spoj - 1 modul
AM5173P A5173P	prolazna utičnica - kao gore, ugrađen 75Ω otpornik
AM5173PT A5173PT	prolazna utičnica - kao gore
AM5173DC A5173DC	oklopljene utičnice - muški spoj Ø 9.5 mm za centralizirane TV VHF/VHF sisteme,
AM5173SAT* A5173SAT*	oklopljene utičnice za TV sa pojedinačnim korisnikom i za daljinski upravljive i centralizirane satelitske sisteme te centraliziranim prolazom prema odobranim kanalima i radio sustavu - muški TV spoj Ø 9.5 mm, SAT spoj i ženski radio spoj Ø 9.5 mm - za instalaciju u pravokutnu kutiju Kat. br. 503E, Kat. br. 504E i Kat. br. 506L
AM5175D*	oklopljene utičnice za sistem sa pojedinačnim korisnikom i za daljinski upravljive i centralizirane satelitske sisteme te centraliziranim prolazom prema odobranim kanalima - muški TV spoj Ø 9.5 mm - SAT spoj - F tip
AM5173DF	TV koaksijalni konektor tip F - impedancija 75 ohma - pričvršćenje vijcima

* Za optimalne performanse, svi spojevi moraju biti iskorisćeni.

POKROVNE PLOČICE

Kat. br.	Opis
AM5164/2	za TV-R utičnice
AM5163/2	za TV-R-SAT utičnice

SPECIJALNE UTIČNICE

Kat. br.	Opis
AM5020 A5020	specijalna nepovratna utičnica 2P 24V 6A - za utikač 2020
AM5120 A5120	mini utičnica 2P-rupe 3mm-udaljenost od centra 13mm za pomoćne i slične krugove 6A 24V SELV - završni spoj
AM5189	DIN 2-polni konektor - za HI-FI uređaje - za lemljenje
AM5190	5 polni DIN konektor za HI-FI i slične uređaje - za lemljenje

ZAVRŠNI OTPORNIK

Kat. br.	Opis
75RTN	završni otpornici 75 ohma za završetak instalacija kod kaskadnog spajanja-dodaje se na zadnju prolaznu utičnicu

POMOĆNI PRIBOR



75RTN

TV utičnica pogled sa stražnje strane

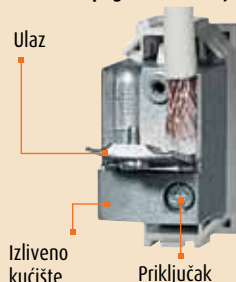

Utičnice

BIJELI MEHANIZMI



AM5113 AM5180 AM5100



AM5180/2



AM5180/3

KREM MEHANIZMI



A5113 A5180 A5100



A5180/2



A5180/3

UTIČNICE U BOJI



A5180R A5180V A5180A

UTIČNICE - TALIJANSKI STANDARD

Kat. br.	Opis
AM5113	utičnica 2P+E 10A 250V a.c. - razmak rupa 19 mm
A5113	zaštićeni ulaz Ø 4 mm
AM5180	utičnica 2P+E 10A i 16A 250V a.c. - razmak rupa 19 mm
A5180	26 mm zaštićeni ulaz
A5180R	utičnica kao gore, crvena
A5180A*	utičnica kao gore, narančasta
A5180V*	utičnica kao gore, zelena
AM5100	nepovratna sigurnosna utičnica 2P+E 10A 250V a.c. za utikač
A5100	2200NA ili 2200NN

* Za naručivanje molimo Vas da nas kontaktirate

UTIČNICE -TALIJANSKI STANDARD DVOSTRUKE I TROSTRUKE

Kat. br.	Opis
AM5180/2	dvostruka utičnica - 2P + E 10A i 16A 250V a.c.
A5180/2	- razmak rupa 19 mm i 26 mm - 2P ekstra (faza-nula) zatvorene
AM5180/3	trostruka utičnica 2P + E 10A i 16A 250V a.c.
A5180/3	- razmak rupa 19 mm i 26 mm - 2P ekstra (faza-nula) zatvorene

Dijagram ožičenja

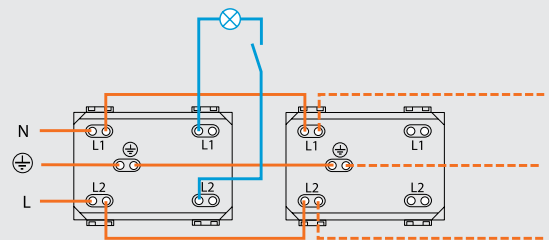

Legend

- pomoćni priključak za mali prenosnik
- predožičena utičnica, spajanje u seriju prolazom kabela

BIJELI MEHANIZMI

AM5440/2



AM5440/2M



AM5440/2P



AM5440/3



AM5440/16

 AM5451/2
 AM5451/2R

AM5460

KREM MEHANIZMI

A5440/2N



A5440/3



A5440/16



A5460

UTIČNICE - NJEMAČKI STANDARD

Kat. br.	Opis
AM5440/2	utičnica 2P+E 10/16A 250V
A5440/2N	zaštićeni kontakti
A5440/2NR	utičnica kao gore, crvena
A5440X2A*	utičnica kao gore, narančasta
A5440X2V*	utičnica kao gore, zelena
AM5440/2M	utičnica 2P+E 10/16A 250V a.c. automatski spoj - 2 modula sa nosivim okvirom i BN ukrasnim okvirom
AM5440/2P	utičnica kao gore s poklopcem
AM5440/3	utičnica 2P+E 10/16A sa bočnim kontaktima i središnjim za uzemljenje, za 10A utikače tip P30 - razmak rupa 19mm
A5440/3R	utičnica kao gore, crvena
AM5440/16	utičnica 2P+E 10A i 16A 250V a.c. 19 mm i 26 mm razmak
A5440/16	rupa, 2-centra zaštićeni kontakti pogodna za talijanske utikače 2P i 2P+E 10/16A, i njemačke 2P+E 16A
A5440/16R	utičnica kao gore, crvena
A5440X16A*	utičnica kao gore, narančasta
A5440X16V*	utičnica kao gore, zelena

* Za naručivanje molimo Vas da nas kontaktirate

DVOSTRUKE UTIČNICE

Kat. br.	Opis
AM5451/2	utičnica 2P+E i 16A 250V - udaljenost između centara 19mm i 26 mm, 2-centra, sa bočnim kontaktima za uzemljenje za utikače njemačkog standarda; pogodna za talijanske utikače 2P i 2P+E 10/16A, i njemačke 2P+E 16A - 2P ekstra (faza-nula) zatvorene
AM5451/2R	utičnica crvena 2P+E i 16A 250V - udaljenost između centara 19mm i 26 mm, 2-centra, sa bočnim kontaktima za uzemljenje za utikače njemačkog standarda; pogodna za talijanske utikače 2P i 2P+E 10/16A, i njemačke 2P+E 16A - 2P ekstra (faza-nula) zatvorene

UTIČNICA ZA BRIJAĆE APARATE

Kat. br.	Opis
AM5460	utičnica za brijanje s transformatorom - napajanje 230V a.c.
A5460	50/60Hz - izlaz 115/230V a.c. 20VA

UTIČNICE U BOJI

A5440/2NR



A5440X2A



A5440X2V



A5440/16R



A5440X16A



A5440X16V



A5440/3R



A5451/2R

RJ i EDP utičnice

BIJELI MEHANIZMI



AM5958/11N AM5982 AM5957/12



AM5959/12



AM5979C5E AM5979C5F
AM5979C6 AM5979C6F
AM5962C6S AM5962C6A



AM5962C5S AM5962C6 AM5974AT5
AM5962C6S AM5962C5E AM5974AT6



AM5951SC AM5951ST AM5951LC

KREM MEHANIZMI



A5958/11N A5982 A5957/12



A5979C5E A5979C6S
A5979C6



A5974AT5
A5974AT6

RJ11 I RJ12 UTIČNICE

Kat. br.	Tip	Broj parica	Za utikač Kat. br.	Tip priključka
AM5958/11N	RJ11	2	2841/2	K10
A5958/11N				
AM5982	RJ11	2	2841/2	A završna
A5982				
AM5957/12	RJ12	2	2841/2	K10
A5957/12				
AM5959/12	RJ12	2	2841/2	K10 (2 modula)

RJ45 UTIČNICE

Kat. br.	Tip	Kategorija	Tip	Tip priključka
AM5979C5E	RJ45	5E	UTP	bez alata (1)
A5979C5E				
AM5979C5F	RJ45	5E	FTP	bez alata (1)
AM5979C6	RJ45	6	UTP	bez alata (1)
A5979C6				
AM5979C6F	RJ45	6	FTP	bez alata (2)
AM5962C6S	RJ45	6	STP	bez alata (2)
A5962C6S				
AM5962C6A	RJ45	6A	STP	bez alata (2)
(1) bez alata				

UTIČNICE ZA OPTIČKE KABELE

Kat. br.	Opis
AM5951ST*	ST priključak - duplex
AM5951SC*	SC priključak - duplex
AM5951LC*	LC priključak - duplex

* Za naručivanje molimo Vas da nas kontaktirate

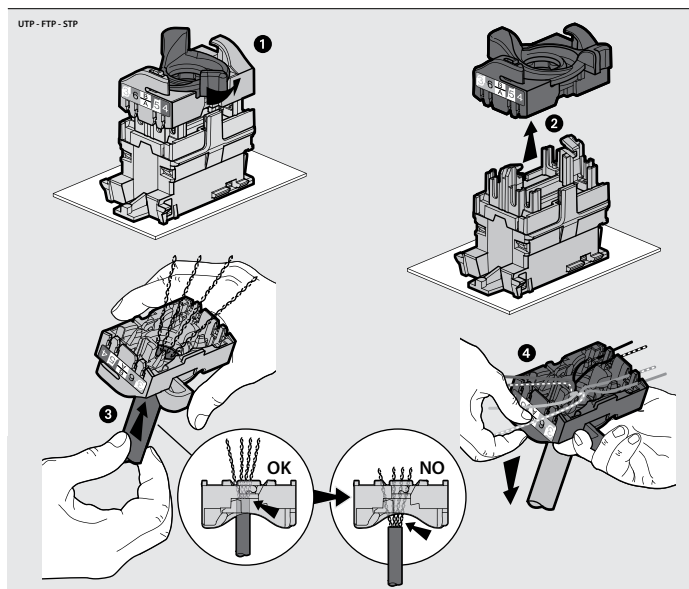

Elektronički uređaji za regulaciju

BIJELI MEHANIZMI



AM5702 AM5706



AM5703
AM5704
AM5707



AM5751 AM5752

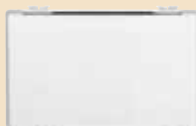

AM5765
AM5765/2

KREM MEHANIZMI



A5702 A5706



A5703



A5751 A5752



A5765

COMMON DEVICES



L4405/60 - L4405/105



L4546

REGULATORI RASVJETE

Kat. br.	Opis
AM5702	Regulator rasvjete - okretni, ugrađena izmjenična sklopka
A5702	MOS-FET teh. - ugrađen osigurač
AM5706	Regulator rasvjete - okretni
A5706	
AM5703	Regulator rasvjete - MOS-FET teh. SOFT START i SOFT STOP
A5703	funkcija postupnog paljenja - ugrađen osigurač
AM5704	Regulator rasvjete
AM5707	Regulator rasvjete dodirni - MOS-FET teh. SOFT START i SOFT STOP
	funkcija postupnog paljenja - ugrađen osigurač

Napomena: za pravilan odabir regulatora rasvjete prema tehničkim karakteristikama pogledajte tablicu na dnu stranice

PASIVNE INFRACRVENE SKLOPKE

Kat. br.	Opis
AM5751	sklopka sa pasivnim infracrvenim detektorom pokreta - varijabilan prag osjetljivosti uređaja sa mogućnošću podešavanja - vrijeme isključenja može se podesiti od 30 sekundi do 10 minuta - relejni izlaz 2A otpor/induktivno - 230V a.c. napajanje - 50 i 60Hz
A5751	
AM5752	sklopka sa pasivnim infracrvenim detektorom pokreta - varijabilan prag osjetljivosti uređaja sa mogućnošću podešavanja - vrijeme isključenja može se podesiti od 30 sekundi do 10 minuta koje se može uključiti preko tipkala - relejni izlaz 6A otpor/2A induktivno - sa 0-A-I selektorskom sklopkom - za opterećenje od 200W maks - 230V a.c. napajanje - 2 modula - 50 i 60Hz
A5752	

ČITAČI ELEKTRONIČKIH KARTICA

Kat. br.	Opis
AM5765	čitač elektroničkih kartica maks napon 30VA 230V a.c.
A5765	- ugrađena lampica - sa vremenskim prekidačem - 3 modula - ugradnja u kutije 503E zajedno sa 503SA nosivim okvirom
AM5765/2	čitač elektroničkih kartica maks napon 30VA 230V a.c. - ugrađena lampica - sa vremenskim prekidačem - 3 modula - za kutije 60mm - ugradnja u kutije sa 500S/23A nosivim okvirom
L4546	kartica sa držačem

POMOĆNI PRIBOR

Elektronički transformatori za halogene lampe

Kat. br.	Opis
L4405/60	Elektronički transformator za halogenu rasvjetu - napajanje 230Va.c. - 50Hz - izlaz 12V - kontrola snage od 20W do 60W
L4405/105	Kao gore - kontrola snage 35W do 105W

Tablica izbora regulatora rasvjete

Tip opterećenja	Snaga	Napon	Frekvencija (Hz)	Kat. br.
Otporna trošila	60 do 500 W	230	50	AM5702
Otporna trošila	100 do 500 W	230	50 i 60	AM5706
Za otporna trošila i feromagnetske transformatore	60 do 500 VA	230	50	AM5703
Za otporna trošila i feromagnetske transformatore	50 do 500 W	127	50 i 60	AM5704
	50 do 1000 W	230		
Za elektroničke transformatore	60 do 250 VA	230	50	AM5707

Elektronički uređaji za regulaciju

BIJELI MEHANIZMI



AM5711
AM5712



AM5155

KREM MEHANIZMI



A5711
A5712



A5155

TERMOSTATI POMOĆNI PRIBOR



AM5721



N4450**



F462



3457

TERMOSTATI I KRONOTERMOSTATI

Kat. br.	Opis
AM5711	elektronički sobni termostat – relejni izlaz sa 1 kontaktom za 2A 250V a.c. – 230V a.c. napajanje – 50 i 60Hz
AM5712	elektronički sobni termostat sa ugrađenom "ljet/zima"
A5712	tipkom – relejni izlaz sa C-NO 2A 250V a.c. kontakt – 230V a.c. napajanje – 50 i 60Hz
AM5721	dnevni/tjedni elektronički kronotermostat za sistem grijanja i ventilacije – osvjetljeni zaslon – napajanje sa 2x1.5V baterijama – mogućnost daljinske aktivacije i spajanja sa vanjskim senzorom temperature – izlazni kontakt 1A – 3 modula

POLYX KLIMA

Kat. br.	Opis
N4450	nadzbukni dnevni/tjedni elektronički kronotermostat za sistem grijanja i ventilacije – LCD zaslon – napajanje sa baterijama 2x1.5V – izlazni kontakt 1A cosφ 0.5 – mogućnost spajanja sa vanjskim senzorom temperature

ELEKTRONIČKI VREMENSKI PREKIDAČ

Kat. br.	Opis
AM5155	elektronički vremenski prekidač sa mogućnošću podešavanja od 1 do 12 minuta – daljinsko upravljanje tipkalima – 230V a.c. napajanje – izlazni kontakt 10AX 250V a.c.

POMOĆNI PRIBOR

Kat. br.	Opis
F462	GSM telefonski aktuator – 4 DIN modula
3457	vanjskim senzor za AM5721

** Nije modularni uređaj za nadzbuknu ugradnju

Zvučna i svjetlosna signalizacija

BIJELI MEHANIZMI



AM5031
AM5041



AM5045
AM5048
AM5045EL

KREM MEHANIZMI



A5031N
A5041N



A5045N
A5048N

ZVONA I ZUJALICE

Kat. br. Opis

AM5045 zujalica 12V a.c. - 5VA - 74dB

A5045N

AM5048 zujalica 230V a.c. - 10VA - 75dB

A5048N

AM5031 zvono 12V a.c. - 5VA - 80dB

A5031N

AM5041 zvono 230V a.c. - 11VA - 80dB

A5041N

ELEKTRONIČKO ZVONO

Kat. br. Opis

AM5755/12 elektroničko zvono - 3 različite vrste zvona sa regulacijom

A5755/12 glasnoće na uređaju- napajanje 12V a.c./d.c. - 2 modula

AM5045EL elektronička zujalica 12V a.c. - 0.9VA, 12V d.c. - 0.5W, 70 dB

INDIKATORI

Kat. br. Opis

AM5062B dvostruki indikator sa 2 difuzora: 1 narančasti + 1 prozirni - za lampice Kat. br. 11250L - 11251L - 11252L

A5062B

AM5064V dvostruki indikator sa 2 difuzora: 1 crveni + 1 zeleni - za lampice

A5064V Kat. br. 11250L (11250LV u zelenom indikatoru) - 11251L - 11252L

AM5060A indikator sa narančastim difuzorom

A5060A - za lampice Kat. br. 11250L - 11251L - 11252L

AM5060R indikator sa crvenim difuzorom

A5060R - za lampice Kat. br. 11250L - 11251L - 11252L

AM5060B indikator sa prozirnim difuzorom

A5060B - za lampice Kat. br. 11250L - 11251L - 11252L

AM5060V indikator sa zelenim difuzorom

A5060V - za lampice Kat. br. 11250L - 11251L - 11252L

PREKLOPNA SKLOPKA I PILOT LAMPE ZA HOTELE

Kat. br. Opis

AM5052H Preklopna sklopka, dvostruka 1P 16 A - 250V a.c. pozicije 1-0-2 za hotele - indikator stanja sobe: "molim ne smetati" i "molim pospremite sobu".

Za korištenje sa pilot lampom Kat. br. AM5064VH

AM5064VH Dvostruki indikator sa crvenim i zelenim difuzorom - "ne smetaj/pospremi sobu" indikator - za lampice Kat. br. 11250L (11250 LV u zelenom indikatoru) - 11251L - 11252L

AM5755/12

A5755/12

AM5062B

AM5064V

A5062B

A5064V

AM5060A

AM5060R

A5060A

A5060R

AM5060B

AM5060V

A5060B

A5060V

AM5052H

AM5064VH

Svjetlosni signalni uređaji i jedinice

INDIKATORI



A5386/12B	A5386/24B	A5386/230B
A5386/12R	A5386/24R	A5386/230R
A5386/12V	A5386/24V	A5386/230V



A5630/12	A5631/12	A5625/12
A5630/24	A5631/24	A5625/24
A5630/230	A5631/230	A5625/230



A5779



L4380/B

A5774/1
A5774/3

A5776/1 - A5776/1L
A5776/3 - A5776/3L

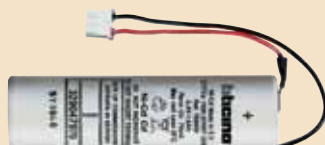
L4784/1
L4784/3

L4786/1
L4786/3

SVJETLOSNE JEDINICE ZA VRATA

Kat. br.	Opis
A5386/12B	napajanje 1V - crvena, zelena, bijela boja
A5386/12V	LED isporučena s proizvodom - 0.6W
A5386/12R	
A5386/24B	napajanje 24Va.c. - crvena, zelena, bijela boja
A5386/24V	LED isporučena s proizvodom - 0.6W
A5386/24R	
A5386/230B	napajanje 230Va.c. - crvena, zelena, bijela boja
A5386/230V	isporučena s proizvodom - 0.6W
A5386/230R	

Napomena: svi modeli se instaliraju između 160 i 205 cm iznad poda. Kada su instalirani uređaji se nalaze **52mm** od zida.

SVJETLO ZA OZNAČAVANJE STEPENICA

Kat. br.	Opis
A5630/12	sa bijelom LED - 12V a.c. - ON OFF sklopka
A5630/24	sa bijelom LED - 24V a.c. - ON OFF sklopka
A5630/230	sa bijelom LED - 230V a.c. - ON OFF sklopka
A5631/12	sa bijelom LED - 12V a.c.
A5631/24	sa bijelom LED - 24V a.c.
A5631/230	sa bijelom LED - 230V a.c.

SVJETLO ZA SIGNALIZACIJU STANJA

Kat. br.	Opis
A5625/12	bijela LED visoke iluminacije - 12V a.c.
A5625/24	bijela LED visoke iluminacije - 24V a.c.
A5625/230	bijela LED visoke iluminacije - 230V a.c.

PRENOSIVA SVJETILJKA

Kat. br.	Opis
A5779	izvlačiva prenosiva svjetiljka automatski se uključuje po nestanku električne energije - sa bazom za punjenje u kompletu - visoke iluminacije bijela LED - punjive NiMH baterije - bez "memory" efekta - autonomija 2 h - niska potrošnja u mirovanju 0.4W - 230V a.c. napajanje - 2 modula
L4380/B	rezervna baterija za prenosivu svjetiljku

PANIK LAMPE

Kat. br.	Opis
A5774/1	panik lampa koja se automatski uključuje po nestanku električne energije - LED indikacija statusa struje - može se isključiti tipkalom - mogućnost daljinskog isklapanja - izmjenjiva i punjiva Ni-Cd baterija - autonomija 1 h - 230V a.c. napajanje - snaga lampe 1W - 4 modula
A5774/3	panik lampa kao gore - 3 h autonomije
A5776/1	panik lampa kao gore - 1 h autonomije snaga lampe 1.3W - 6 modula
A5776/3	panik lampa kao gore - 3 h autonomije
A5776/1L	panik lampa kao gore - sa funkcijom stalnog osvjetljenja - za prostorije koje trebaju svjetlost 24h - 1 h autonomije
A5776/3L	panik lampa kao gore - 3 h autonomije
L4784/1	rezervna baterija za lampu Kat. br. A5774/1
L4784/3	rezervna baterija za lampu Kat. br. A5774/3
L4786/1	rezervna baterija za lampu Kat. br. A5776/1 i A5776/1L
L4786/3	rezervna baterija za lampu Kat. br. A5776/3 i A5776/3L

Sigurnosni uređaji

BIJELI MEHANIZMI



AM5206S AM5246S
AM5210S AM5250S
AM5216S AM5256S

KREM MEHANIZMI



A5206S A5246S
A5210S A5250S
A5216S A5256S



AM5114



AM5130



AM5088 AM5471



A5088 A5471

AUTOMATSKE TERMO MAGNETSKE SKLOPKE 230V A.C.

Kat. br.	Opis
AM5206S	automatska termo magnetska sklopka 1P+N 6A 230V a.c.
A5206S	kontakti otvoreni/zatvoreni indikator - prekidna moć 1500A 230V a.c.
AM5210S	kao gore 10A - prekidna moć 3000A 230V a.c.
A5210S	
AM5216S	kao gore 16A - prekidna moć 3000A 230V a.c.
A5216S	

KOMB STRUJNE ZAŠTITNE SKLOPKE I OSIGURAČA 230 VA.C.

Kat. br.	Opis
AM5246S	Salvavita - dvopolna automatska termo magnetska sklopka sa 1 zaštićenim polom I.n 10mA - 6A 230V a.c. - kontakti otvoreni/zatvoreni indikator - test tipkalo - prekidna moć 1500A 230V a.c. - 2 modula
AM5250S	Salvavita kao gore - 10A - prekidna moć 3000A 230V a.c.
A5250S	
AM5256S	Salvavita kao gore - 16A - prekidna moć 3000A 230V a.c.
A5256S	

UTIČNICE S TERMOMAGNETSKOM SKLOPKOM

2P+E utičnica sa zaštićenim kontaktima - stupanj zaštite 2.1 - povezane sa automatskom termo magnetskom sklopkom 1P + N - 2 modula

Kat. br.	In	Vn	Prekidna moć
AM5114	10A	230Va.c.	3000A - 230Va.c.
AM5130	16A	230Va.c.	3000A - 230Va.c.

NOSAČ OSIGURAČA I OSIGURAČI

Kat. br.	Opis
AM5088	nosач osigurača za 5 x 20 i 6.3 x 32 osigurače - maks. 10A 250V a.c.
A5088	

PRENAPONSKA ZAŠTITA

Kat. br.	Opis
AM5471	1P odvodnik prenapona za kombinaciju sa glavnom utičnicom
A5471	- nazivna struja pražnjenja In=1kA - maksimalna struja Imax=2kA - maks sigurnosni napon Up=1kV - nazivni napon Un=110-230V a.c. - maks stalni napon Uc=250V a.c.

Detektori plina

BIJELI MEHANIZMI



AM5731/12



AM5732/12



AM5730



AM5734

KREM MEHANIZMI



A5731/12



A5732/12



A5730



A5734

DETEKTORI PLINA

Kat. br.	Opis
AM5731/12	Detektor metana sa optičkim i zvučnim signalom 85dB
A5731/12	alarm signal - unutarnja samodijagnoza - postavljena za upravljanje ponavljačem signala - napajanje 12V a.c./d.c. - 2 modula
AM5732/12	detektor kao gore za LPG plin
A5732/12	

PONAVLJAČ SIGNALA

Kat. br.	Opis
AM5730	Ponavljač signala za detektore plina - optički/zvučni signal - relejni izlaz sa 1 preklopnim kontaktom
A5730	6A omsko 2A induktivno - 2 modula

TRANSFORMATORI

Kat. br.	Opis
AM5734	sigurnosni transformator - ulaz 230V a.c. - 50/60Hz - izlaz 12V a.c. - 4VA - 2 modula
A5734	
F91/12E	DIN sigurnosni transformator - ulaz 230V a.c. - 50/60Hz - izlaz 12V a.c. - 6VA - za ugradnju u DIN šinu
	3 modula

SOLENOIDNI VENTIL

Kat. br.	Opis
L4525/12NO	NO plinski solenoidni ventil - ručni reset - napajanje 12V 50Hz - snaga 3VA - potrošnja u mirnom stanju 0 - maksimalni tlak 500mbar - stupanj zaštite IP 65 - radna temperatura -15 do +60°C - 3/4" kapice i 1/2" redukcija su dio isporuke

POMOĆNI PRIBOR



L4525/12NO



F91/12E

Lampice - kutije za ugradnju i dodatni pribor

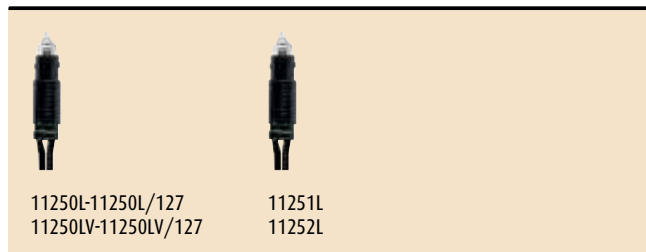

11250L-11250L/127
11250LV-11250LV/127

11251L
11252L

LAMPICE

Kat. br.	Opis
11250L	230V - prozirna
11250L/127	127V - prozirna
11250LV	230V - zelena
11250LV/127	127V - zelena
11251L	signalna 12V
11252L	signalna 24V



503CG

503EC-504EC-506EC

KUTIJE I POMOĆNI PRIBOR

Kat. br.	Opis
503CG	zaštitni pokrov za podžbukne kutije koristi se kod završnih radova npr. žbukanja
503EC	završna pokrovna pločica za zatvaranje - može se bojati - za Kat. br. 503E
504EC	završna pokrovna pločica kao gore za Kat. br. 504E
506EC	završna pokrovna pločica kao gore za Kat. br. 506E
503EV	unutarnja pregrada - vertikalna
506EV	unutarnja pregrada za Kat. br. 506E - horizontalna
503ED	horizontalni i vertikalni spojnik
503DE	unutarnja pregrada za kutije Kat. br. 504E
AM5590/3	zaštitno kućište - na 3 modula okvir - korištenje kod završnih radova

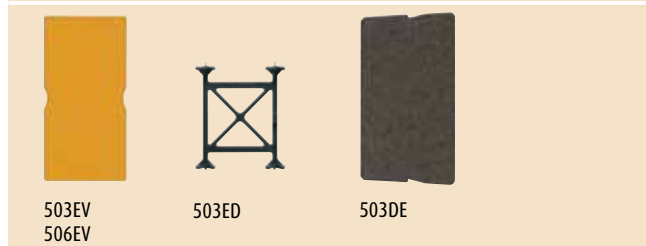

503EV
506EV

503ED

503DE

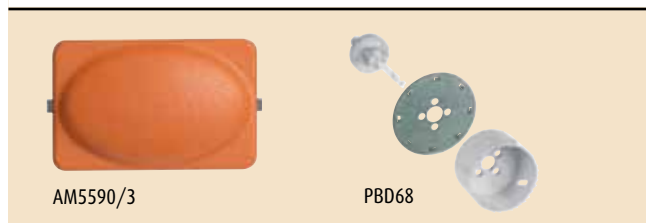

AM5590/3

PBD68

DODATNI PRIBOR ZA INSTALACIJU

Kat. br.	Opis
PBD68	kružni rezač za ugradnju kutija u gips ploče

LAMPICE ZA POZADINSKU RASVJETU

Za uređaje - Kat. br.	11251L – 11252L	11250L – 11250LV
AM5001, AM5003, AM5005, AM5005/1 AM5001L, AM5003L, AM5005L	■	■
AM5011, AM5012	■	■
AM5054, AM5057R, AM5057V*, AM5057A AM5008	■	■
AM5060A, AM5060B, AM5060R, AM5060V AM5062B, AM5064V*	■	■
A5385/12..., A5385/24..., A5385/230...	■	■

* za pilot lampe sa zelenim difuzorom i napajanjem 230V, koristite lampice 11250LV

NAPOMENA: lista MÀTIX bijelih mehanizama i usporednih krem mehanizama (Kat. br. A...)

UKRASNI OKVIRI: INSTALACIJA I IZBOR BOJA



SADRŽAJ

- 32 Instalacija u MÀTIX nosive okvire
- 33 MÀTIX ukrasni okviri
- 34 Kućišta i uređaji za zaštitu
- 36 Instalacija na DIN šine
- 37 MÀTIX: Rješenja za poslovnu primjenu

Instalacija u MÀTIX nosive okvire

Kutije	Nosivi okviri	Broj modula	Ukrasni okviri
<p>500 (Ø 60x44 mm) PB502 (Ø 68x51 mm)</p> <p>502E (70x70x50 mm)</p>	<p>500SM2A</p> <p>500S/23A</p>	<p>2 modula</p>	<p>AM4802...</p> <p>*AM4819...</p>
<p>503E (108x74x53.5 mm) modularno</p> <p>503BP (124x87x45 mm)</p> <p>PB503 (109x68x51 mm)</p> <p>503AP (124x87x45 mm)</p>	<p>503SA</p> <p>503S/2A</p>	<p>3 modula</p> <p>2 modula</p>	<p>*AM4803M1...</p> <p>AM4803...</p> <p>*AM4819...</p>
<p>504E (132x74x52 mm)</p> <p>PB504 (131.5x68x51 mm)</p>	<p>504SA</p>	<p>4 modula</p>	<p>AM4804...</p>
<p>506L (183.5x90x53.5 mm)</p> <p>PB506 (182x68x51 mm)</p>	<p>506LSA</p>	<p>6 modula</p>	<p>AM4806...</p>
<p>506E (108x118x51.5 mm)</p> <p>PB526 (109x114x51 mm)</p>	<p>506SA</p>	<p>3+3 modula</p>	<p>AM4826...</p>







MÀTIX ukrasni okviri

Opis	Bijela	Bjelokost	Pijesak	Pepeo
Neutralne	 BBN	 BAV	 BCD	 BCN
Opis	Srebro	Željezo	Zlato	Titan
Metalne	 MSL	 MIR	 MGL	 MTA
Opis	Limun bijela	Terracotta	Tamno smeđa	Mercury plava
Teksture	 TBC	 TRT	 TGG	 TBM
Opis	Ledeno bijela	Krem	Zelena	Tirkizno plava
Boje	 CBN	 CAV	 CVC	 CAR
Opis	Crvena	Narančasta	Tamno zelena	Plava
Boje	 CRD	 CAB	 CVS	 CBU
Opis	Sjajni krom	Sjajno Zlatna	Tamni Nikal	Saten Zlatna
Galvanizirane	 GCR	 GOR	 GNN	 GOS







NAPOMENA:

Uređji su dostupni i u krem verziji; za više detalja pregledajte dio kataloga sa uređajima.

IP55 kućišta

Opis		Opis		Opis	
Instalacija na 502, 502E podžbukne kutije 2 modula siva RAL7035		Instalacija na 502, 502E podžbukne kutije 2 modula tamno siva			
	25602		25602S		
Instalacija na 503E podžbukne kutije 3 modula siva RAL7035		Instalacija na 503E podžbukne kutije 3 modula tamno siva		Instalacija na 503E podžbukne kutije slijepi poklopac siva RAL7035	
	25603		25603S		23940
Instalacija on 504E podžbukne kutije 4 modula siva RAL7035		Instalacija on 504E podžbukne kutije 4 modula tamno siva			
	25604		25604S		













IDROBOX PLUS

Opis		Opis		Opis	
26003 - nadžbukna izmjenična sklopka - IP55		nadžbukno kućište - 2 MÀTIX modula - IP55 sa zatvorenim poklopcem		tipkalo s oznakom - za 503E, 502E, 502 kutije - boje: antracit, bijela i tech - IP55	
26005 - nadžbukno tipkalo - IP55	26003 - 26005		26055		26108L - 26108N - 261018T
23953 - adapter za 503E kutije za montiranje referenci: 26003, 26005, 26055.		nadžbukno kućište - sa izmjeničnom sklopkom i kućištem za 2 MÀTIX modula - IP55		nadžbukno kućište za MÀTIX utičnice - IP66 (IP zaštita je osigurana tek kad je utikač priključen i kućište zatvoreno).	
	23953		26200		26066

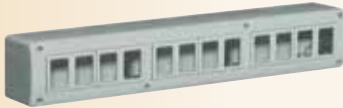





Infracrvene sklopke (relejni kontakti 8A 250V a.c.)

Opis		Opis		Opis	
kut detekcije 140° IP44 zaštita		kut detekcije 180° IP54 zaštita		kut detekcije 270° IP54 zaštita	
	23972N		25550/180		25550/270

IP40 horizontalna i vertikalna nadžbukna kućišta











Opis	Opis	Opis	
1 modul  25401	2 modula  25402	3 modula  25403	
4 modula  25404	4 modula  25404/2	6 modula  25406	
8 modula  25408	12 modula  25412	16 modula  25416	
4 modula  25404/2V	6 modula  25406V	8 modula  25408V	12 modula  25412V

IP55 horizontalna i vertikalna nadžbukna kućišta

Opis	Opis	Opis
1 horizontalni modul  25501	2 horizontalna modula  25502	3 horizontalna modula  25503
4 horizontalna modula  25504	8 vertikalna modula  25508V	12 vertikalna modula  25512V



MÀTIX: Instalacija na DIN šinu

INSTALACIJA NA ŠINE

Kutije	Nosivi okvir	Broj modula	Nosivi/ukrasni okvir
 510L		 1 modul	 AM4811/1BN
		 1 modul	 AM4811/1SL
 510L +  510L		 2 modula	 AM4811/2BN
		 2 modula	 AM4811/2SL

NAPOMENA: moguća instalacija bijelih i krem uređaja

INSTALACIJA NA DIN ŠINU

Opis	Opis
adapter 2 modula za njemački standard utičnice  F80CMT	adapter 6 modula za panik lampe  F80CMT/6

MATIX: Rješenja za poslovnu primjenu

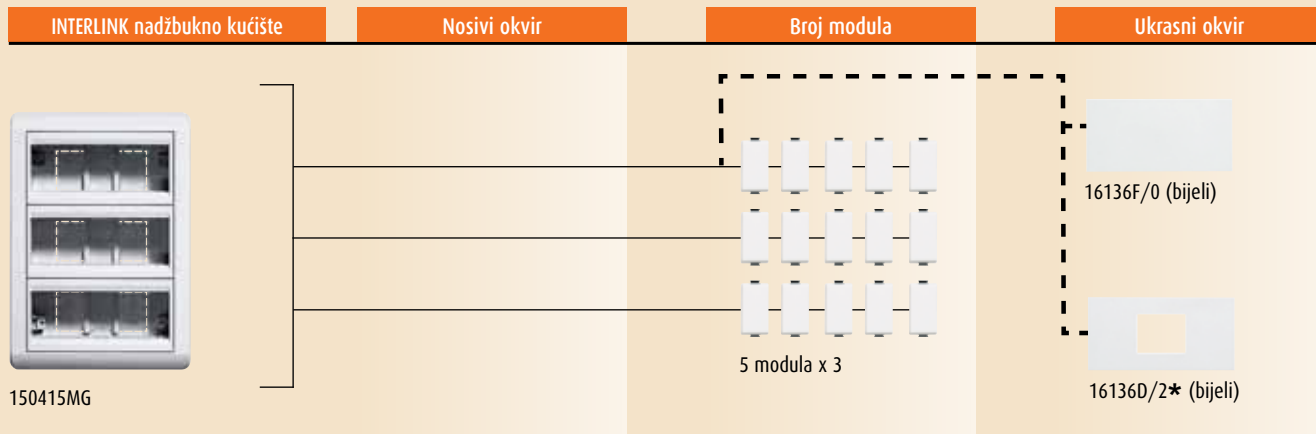

NAPOMENA: mogućnost instalacije bijelih i krem uređaja
*ukrasni okvir za 2 DIN modula

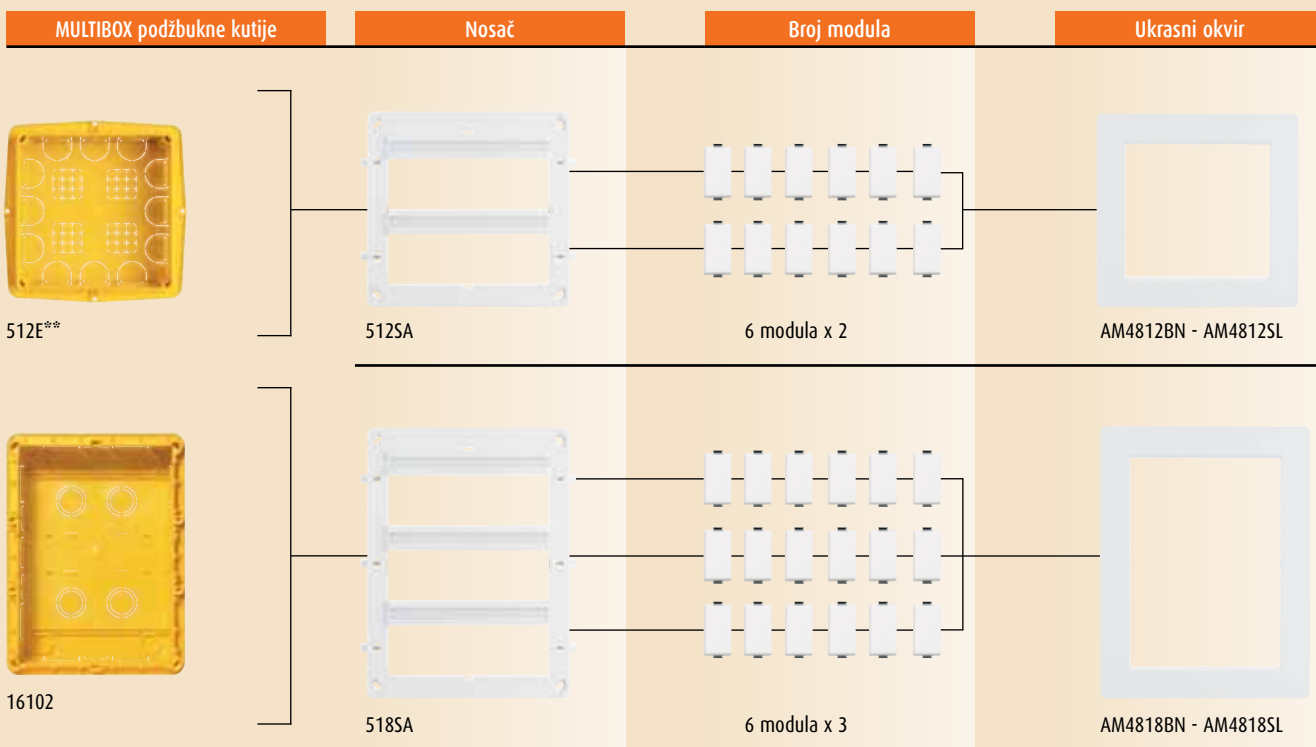

NAPOMENA: reference sa AV, CN, CD, TA, IR, GL, su dostupne po narudžbi
mogućnost instalacije bijelih i krem uređaja

** pomoćni pribor za 512E kutiju:
512EC - poklopac
512EV - pregrada



NAPOMENA: mogućnost instalacije bijelih i krem uređaja

IDROBOX i IDROBOX PLUS



SADRŽAJ



40 **Generalne karakteristike**

Katalog

44 IP40 kućišta za MÀTIX

45 IP55 kućišta i pomoćni pribor za MÀTIX

46 Razvodne kutije i dodatni pribor
Elektronički uređaji u zaštićenom kućištu

47 IDROBOX PLUS

IDROBOX PLUS: IP55 uređaji i kućišta

■ ELIMINIRA SVE PROBLEME SA VLAGOM ILI PRAŠINOM

■ MAKSIMALNA I DUGOTRAJNA OTPORNOST NA VREMENSKE UVJETE

■ UNAPRIJEĐEN DIZAJN: DIREKTNJA KONTROLA UREĐAJA I UPRAVLJANJE



2 verzije: Izmjenična sklopka i tipkalo



Kućište s poklopcem (2 MATIX modula)



Izmjenična sklopka i kućište s poklopcem



Tipkalo s oznakom imena za 503E (dostupno i u LIVING, LIGHT, LIGHT TECH linijama proizvoda)

IDROBOX PLUS: IP55 uređaji i kućišta

Za instalaciju u Vašem domu.

PRIMJERI UGRAĐENIH UREĐAJA

- DVORIŠNA VRATA:
- tipkalo



- ULAZNA VRATA :
- tipkalo s oznakom imena



- PODRUM I ZAJEDNIČKE PROSTORIJE:
- kućište s poklopcem
- izmjenična sklopka ili tipkalo



- GARAŽA I PODRUM:
- Izmjenična sklopka i kućište s poklopcem



IDROBOX PLUS

IP66 kućište: zaštita s priključenim kabelom



IP66 kućište

■ OSIGURANA IP66 ZAŠTITA ZA SVE TIPOVE UTIKAČA:



ravni utikač

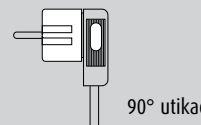

90° utikač



RJ konektor



PRIMJERI UGRAĐENIH UREĐAJA

■ VANJSKA PRIMJENA:



IDROBOX: IP40 I IP55 kućišta za MÀTIX uređaje

Idrobox je kompletna linija IP40 i IP55 kućišta za upotrebu MÀTIX proizvoda u najrazličitijim okruženjima: od ureda do stanova.



IP40 kućišta za MÀTIX



25401



25402



25403



25404



25404/2



25406



25408

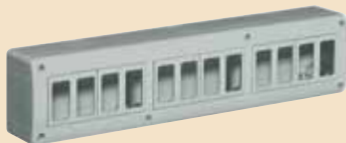

25412



25416

HORIZONTALNA NADŽBUKNA KUĆIŠTA - IP40

Horizontalna nadžbukna kućišta sa kutijom i poklopcem - IP40.

Kat. br.	Broj rupa Ø 23 mm sa uvodnicom	Broj rupa Ø 23 mm izbijanje	Broj modula koji se mogu instalirati	Pregrada koja se može instalirati
25401	1	2	1	
25402	1	2	2	
25403	1	4	3	
25404		9	4	
25404/2		9	2+2	1 (25701V)
25406		11	3+3	1 (25701V)
25408		11	4+4	1 (25701V)
25412		11	4+4+4	2 (25701V)
25416		14	4+4+4+4	3 (25701V)



25404/2V



25406V



25408V



25412V

VERTIKALNA NADŽBUKNA KUĆIŠTA - IP40

Vertikalna nadžbukna kućišta sa kutijom i poklopcem - IP40.

Kat. br.	Broj rupa Ø 23 mm sa uvodnicom	Broj rupa Ø 23 mm izbijanje	Broj modula koji se mogu instalirati	Pregrada koja se može instalirati
25404/2V		9	4	1 (25701V)
25406V		9	6	2 (25701V)
25408V		13	8	1 (25701V)
25412V		15	12	2 (25701V)

IP55 kućišta i dodatni pribor za MÀTIX



25501

25502



25503

25504



25508V

25512V

HORIZONTALNA NADŽBUKNA KUĆIŠTA - IP55

Horizontalna nadžbukna kućišta sa kutijom i poklopcem - IP55.

Kat.br.	Broj rupa Ø 23 mm		Broj modula koji se mogu instalirati	Pregrada Kat.br. 25701V
	sa ulovnicom za kabel	za izbijanje		
25501	1	2	1	
25502	1	2	2	
25503	1	4	3	
25504		9	4	

VERTIKALNA NADŽBUKNA KUĆIŠTA - IP55

Vertikalna nadžbukna kućišta sa kutijom i poklopcem - IP55.

Kat.br.	Broj rupa Ø 23 mm		Broj modula koji se mogu instalirati	Pregrada Kat.br. 25701V
	sa ulovnicom za kabel	za izbijanje		
25508V		13	4+4	1 (25701)
25512V		15	4+4+4	2 (25701)



25700

25700F/16
25700F/2025701
25701V

25702

DODATNI PRIBOR ZA IP40 I IP55 KUĆIŠTA

Kat.br.	Opis
25700	elastična ulovnica kabela Ø od 5 do 14-16-20 mm - IP55
25700F/16	IP55 ulovnica za Ø 16 mm cijevi
25700F/20	IP55 ulovnica za Ø 20 mm cijevi
25701	horizontalna pregrada
25701V	vertikalna pregrada
25702	interni priključak za uzemljenje



25602

25603

25604



25602S

25603S

25604S

OKVIRI SA ZAŠTITOM

Okviri sa zaštitom, za instalaciju MÀTIX uređaja u 502E kutiju

Kat.br.	Opis
25602	siva RAL7035
25602S	tamno siva

Okviri sa zaštitom, za instalaciju MÀTIX uređaja u 503E kutiju

Kat.br.	Opis
25603	siva RAL7035
25603S	tamno siva

Okviri sa zaštitom, za instalaciju MÀTIX uređaja u 504E kutiju

Kat.br.	Opis
25604	siva RAL7035
25604S	tamno siva

Razvodne kutije i dodatni pribor



23983



23984



23940



23854



23858



23866/20

IP55 NADŽBUKNE KUTIJE

Kat.br.	Modul	Dimenzije u mm
23983	503	94x82x58
23984	504	142x82x58

POKLOPAC ZA IP55 INSTALACIJA NA 503E KUTIJU

Kat.br.	Modul	Dimenzije u mm
23940	slijepi	115x103x8

DODATNI PRIBOR ZA KUTIJE

Kat.br.	Opis
23854	uvodnica Ø 16 mm
23858	adapter - PG16
23866/20	uvodnica za cijevi Ø 20 mm

Elektronički uređaji u zaštićenom kućištu



23972N

 25550/180
25550/270

PASIVNE INFRACRVENE SKLOPKE S DETEKCIJOM POKRETA

Pasivne infracrvene sklopke s detekcijom pokreta - napajanje 230V a.c. - relejni kontakt 8A 250V

Kat.br.	Horizontalni kut detekcije
23972N	140°
25550/180	180°
25550/270	270°

IDROBOX PLUS



IP55 UREĐAJI

Kat.br.	Opis
26003	nadžbukna izmjenična sklopka 16A 250 V a.c. sa axial sklopkom, pozadinska rasvjeta s LED Kat.br. H4743B/230 (kupuje se posebno)
26005	nadžbukno tipkalo 10A 250 V a.c. sa axial sklopkom, pozadinska rasvjeta s LED Kat.br. H4743B/230 (kupuje se posebno)
26055	nadžbukno kućište za MATIX uređaje - kapacitet 2 modula - garantirana IP55 sa spušenim poklopcem
26200	monoblok nadžbukno kućište 2 modula, opremljeno sa izmjeničnom sklopkom i IP55 kućištem - Može se instalirati horizontalno i vertikalno. Izmjenična sklopka: 16A 250 V a.c. sa axial sklopkom, pozadinska rasvjeta s LED Kat.br. H4743B/230 (kupuje se posebno). Kućište s poklopcem: za MATIX uređaje - kapacitet 2 modula.
23953	adapter za instalaciju IDROBOX PLUS uređaja Kat.br. 26003 - 26005 - 26055 na kutiju 503E.
26108L	tipkalo s nazivom 10A 250 V a.c. osvijetljeno s LED
26108N	(ugrađeno) - može se instalirati na 503E, 502E,
26108T	502 kutije - 3 boje: LIVING (Kat.br. 26108L), LIGHT (Kat.br. 26108N), LIGHT TECH (Kat.br. 26108T)

NAPOMENA: IDROBOX - PLUS su kompatibilni sa IDROBOX dodatnim priborom

IP66 KUĆIŠTE

Kat.br.	Opis
26066	kućište za MATIX utičnice (njemački standard, 2-centra, RJ) - kapacitet 2 modula. Osigurana IP66 zaštita - za nadžbuknu instalaciju



Legrand d.o.o

Zavrtnica 17, 10 000 Zagreb

Tel.: +385 1 60 64 350

Fax.: + 385 1 60 64 352

e-mail: legrand@legrand.hr

www.legrand.hr